

CO2 ROOM DIFFUSION

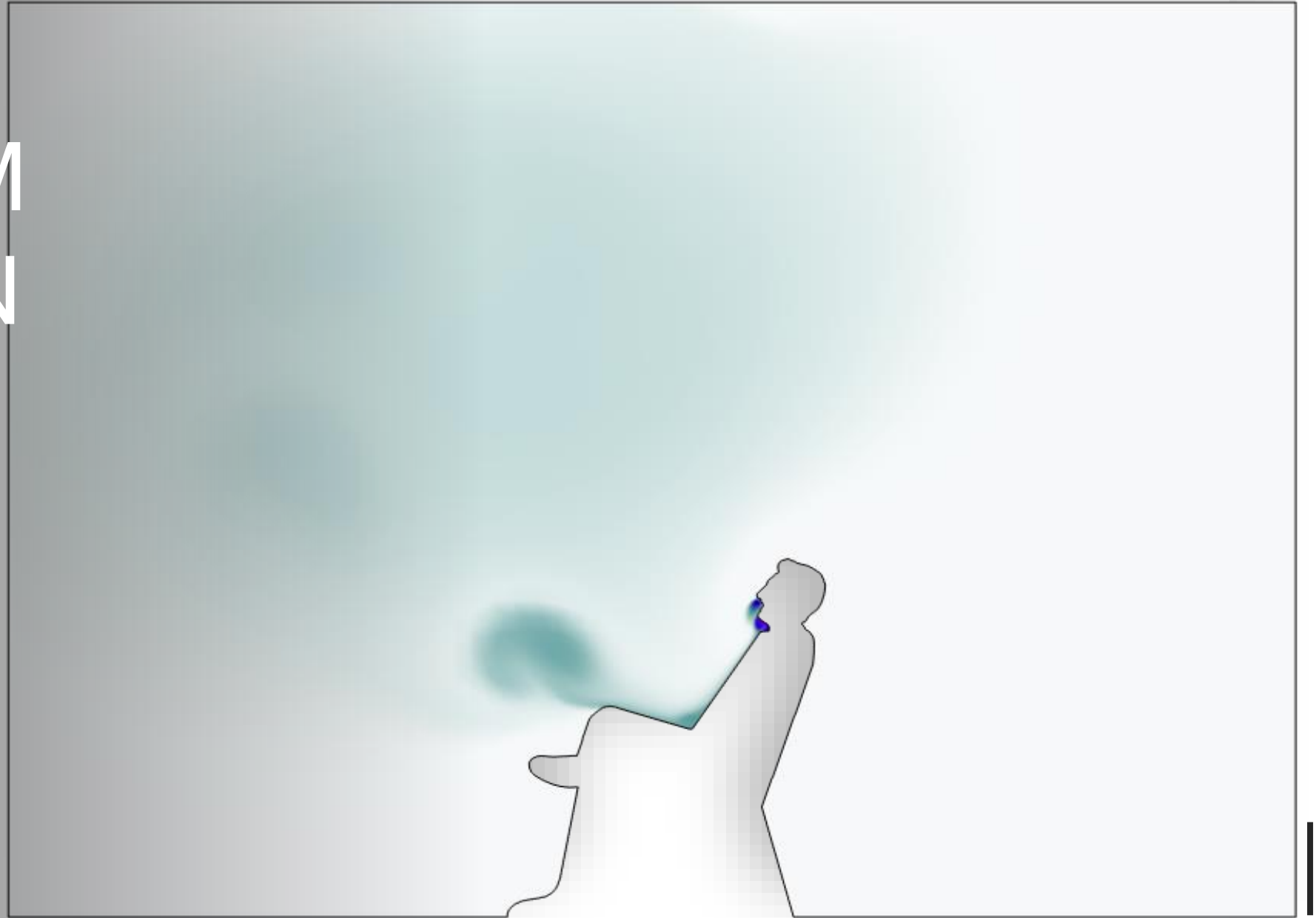

GOALS & USES



Determination of critical CO₂ concentration in a closed space

App with variable parameters for room size, number of people, breath frequency etc.

Useful for office and learning spaces

Applicable to space shuttles and planes

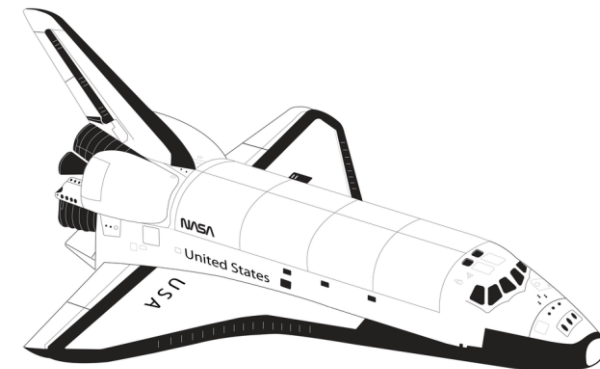















2D

Figuring out how to model human breathing

Passive approach with interior fan (no chemical reaction)

Monitoring CO₂ concentration and diffusion

Optimizing volume flow

- ✓  Turbulent Flow, SST (*spf*)
 -  Fluid Properties 1
 -  Initial Values 1
 -  Wall 1
 -  Gravity 1
 -  Interior Fan 1
 -  Pressure Point Constraint 1
- ✓  Transport of Diluted Species (*tds*)
 -  Transport Properties 1
 -  No Flux 1
 -  Initial Values 1
 -  Inflow 1
- ✓  Multiphysics
 -  Reacting Flow, Diluted Species 1 (*rfd1*)

APP

CO2 ROOM DIFFUSION

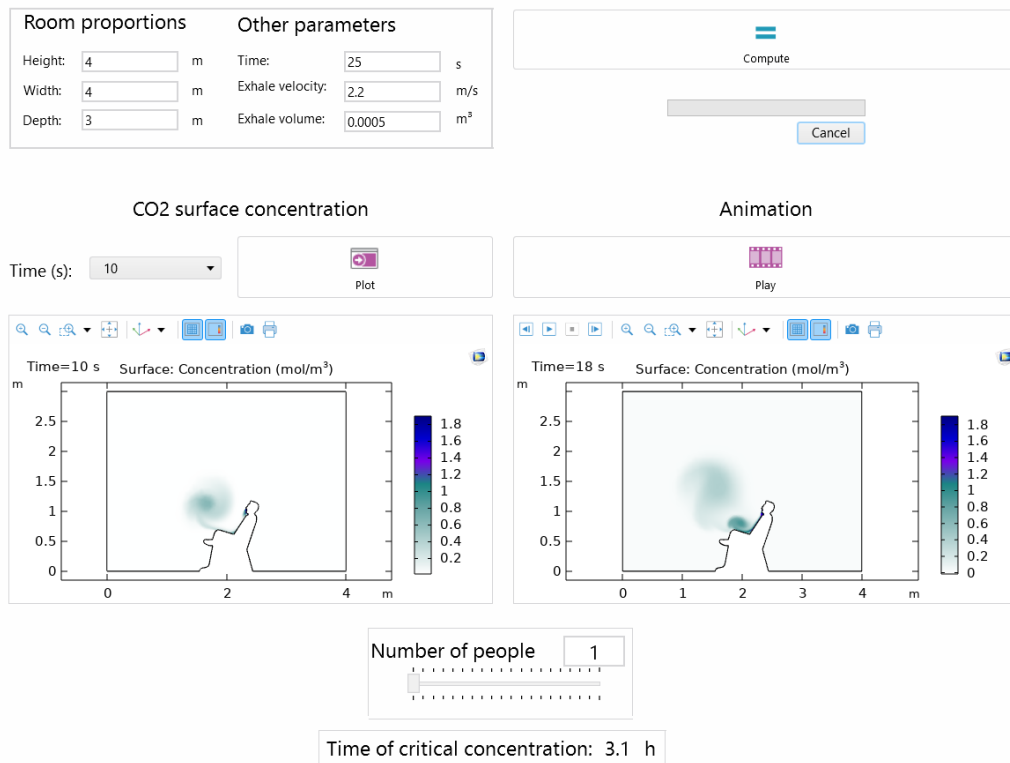

Variable parameters

Surface concentration

Numerical computation of critical concentration

RESULTS & PROBLEMS

Visualization of breathing

Average concentration too high

Long computation time

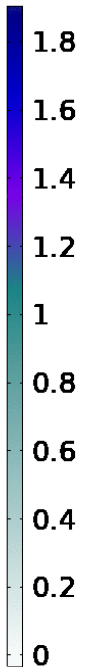
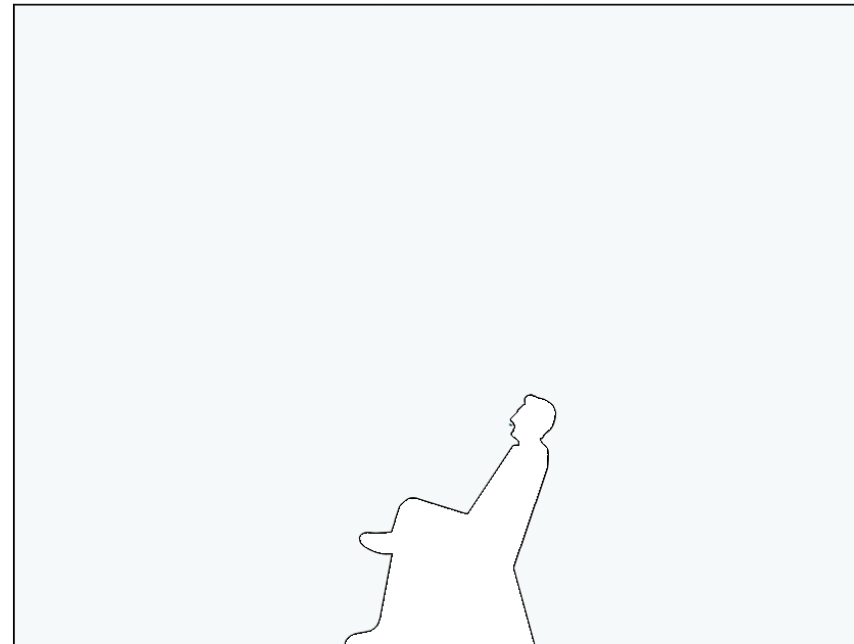

FUTURE IMPROVEMENTS

Better meshing (focused on nostrils)

Out of plane thickness in 2D

Full conversion to 3D

Neural network

Chemical reaction accounting for oxygen

Adaptability for larger number of people

Implementation of ventilation system

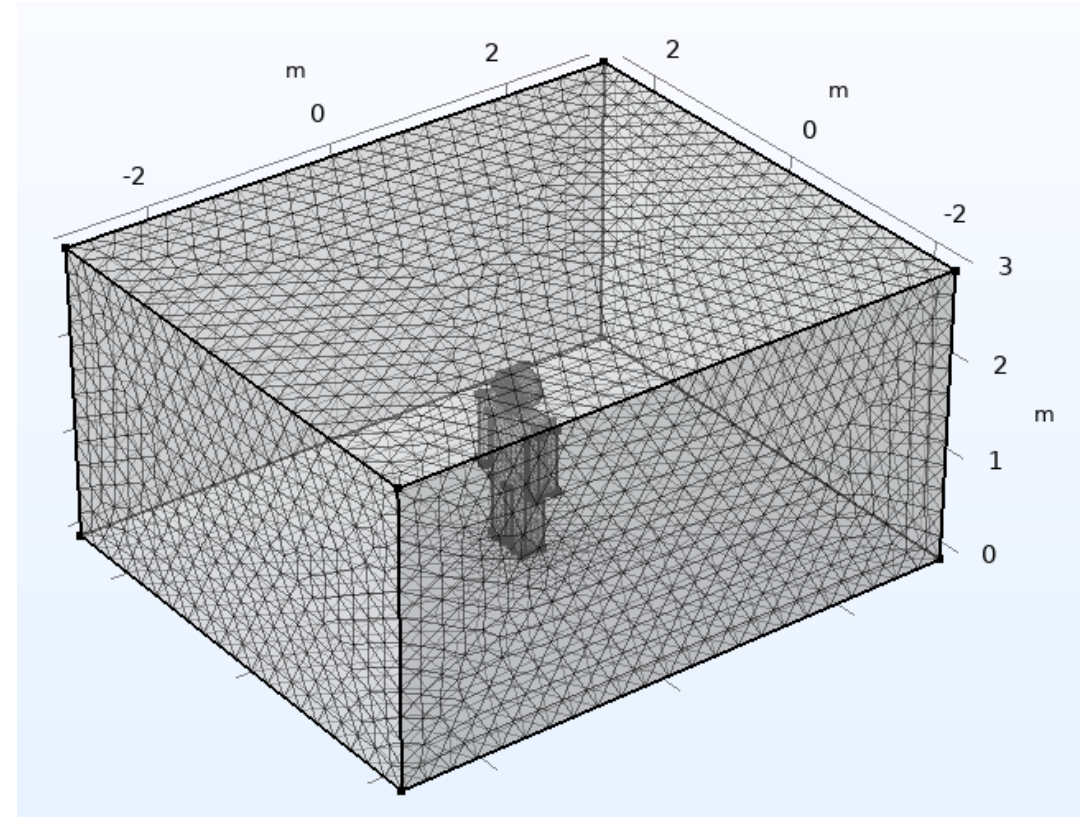

3D

Extremely long computation time

Problems with meshing

Piecewise function

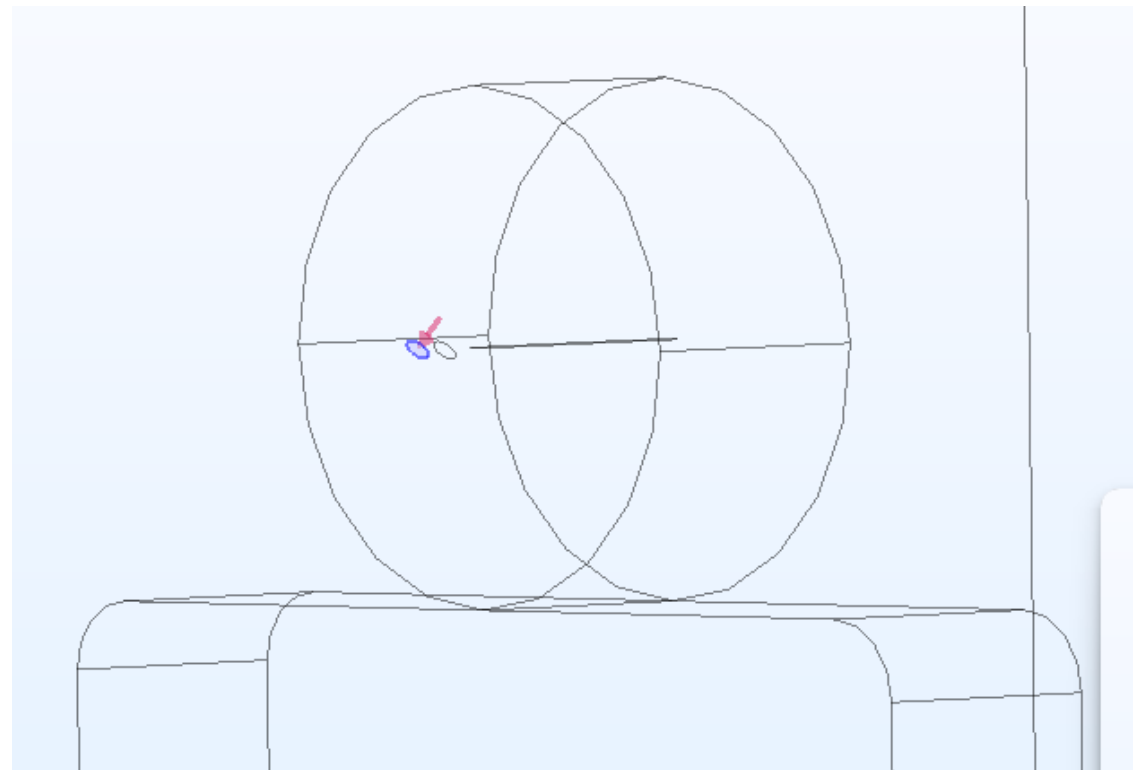

THAK YOU FOR YOUR ATTENTION

Sources

Jirka vysvětluje věci. Online. Available at: <https://www.youtube.com/watch?v=Y1PJQTnbQbl>. [cit. 2024-05-23].

Pleil JD, Ariel Geer Wallace M, Davis MD, Matty CM. The physics of human breathing: flow, timing, volume, and pressure parameters for normal, on-demand, and ventilator respiration. *J Breath Res*. 2021 Sep 27;15(4):10.1088/1752-7163/ac2589. doi: 10.1088/1752-7163/ac2589. PMID: 34507310; PMCID: PMC8672270.

LINDSEY, REBECCA. Climate Change: Atmospheric Carbon Dioxide. Online. 2024. Available at: <https://www.climate.gov/news-features/understanding-climate/climate-change-atmospheric-carbon-dioxide>. [cit. 2024-05-23].

